

## Operating Missions as Nodes on the Internet (OMNI)

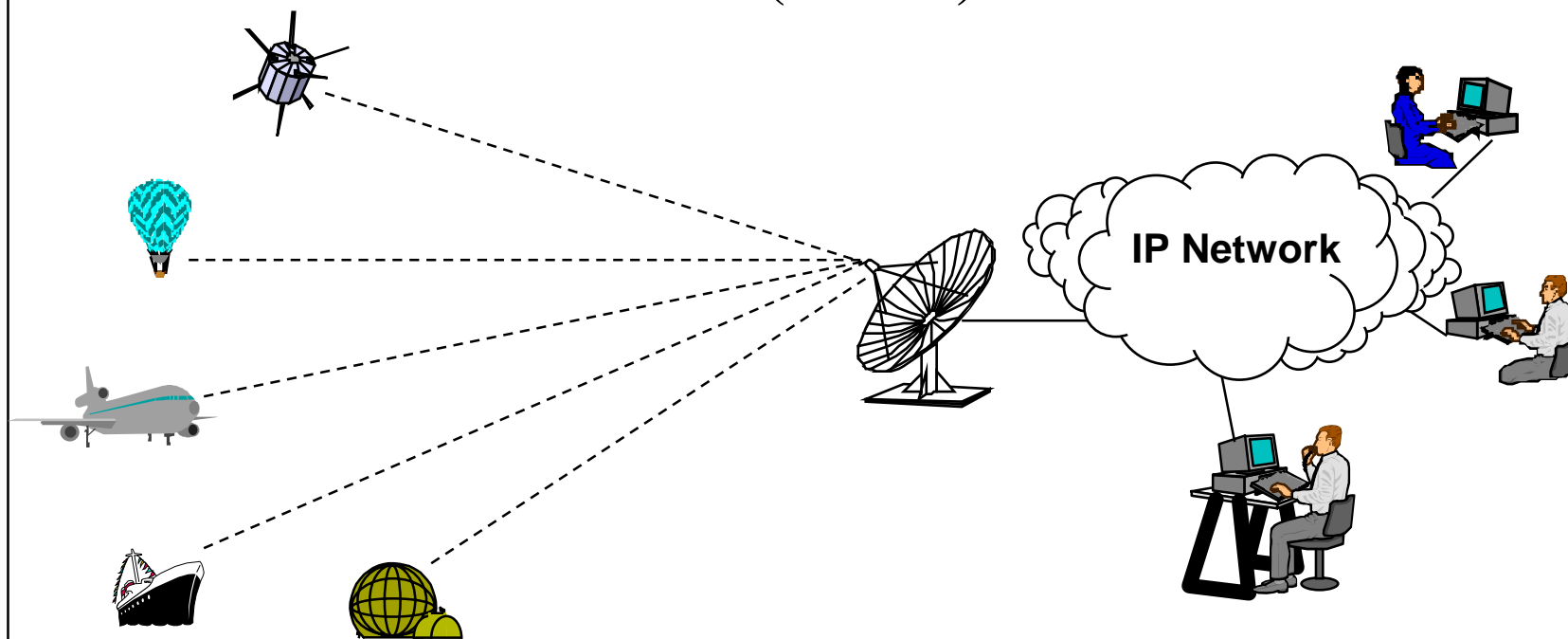

March 1999

Keith Hogie, Francis Hallahan, Tinh Le



## Current Mission Data Flows



- Old satellites
  - Instrument data records are sampled in small pieces
  - Samples commutated across multiple communication frames
  - Frames inserted into Nascom 4800 bit blocks at ground tracking station
  - Nascom blocks delivered to control centers and level-zero processor (LZP) via IP network
- Newer satellites
  - Instrument records generated in CCSDS packet formats
  - CCSDS packets multiplexed into CCSDS frames
  - CCSDS frames inserted into Nascom 4800 bit blocks at ground tracking station
  - Nascom blocks delivered to control centers and level-zero processor (LZP) via IP network
- Some new missions
  - CCSDS frames synchronized at tracking station and delivered to control centers and LZP via IP
- Custom built front-end processors at each satellite's control center and LZP system synchronize data to locate frames and decommutate data or extract packets
- Data must be captured and reformatted for further distribution to scientists and end-users
- A large amount of custom and expensive ground communication equipment must be built and maintained to support NASA unique formats
- Communication between satellites and cross-support between missions is very difficult or impossible



# Current Mission Data Flows

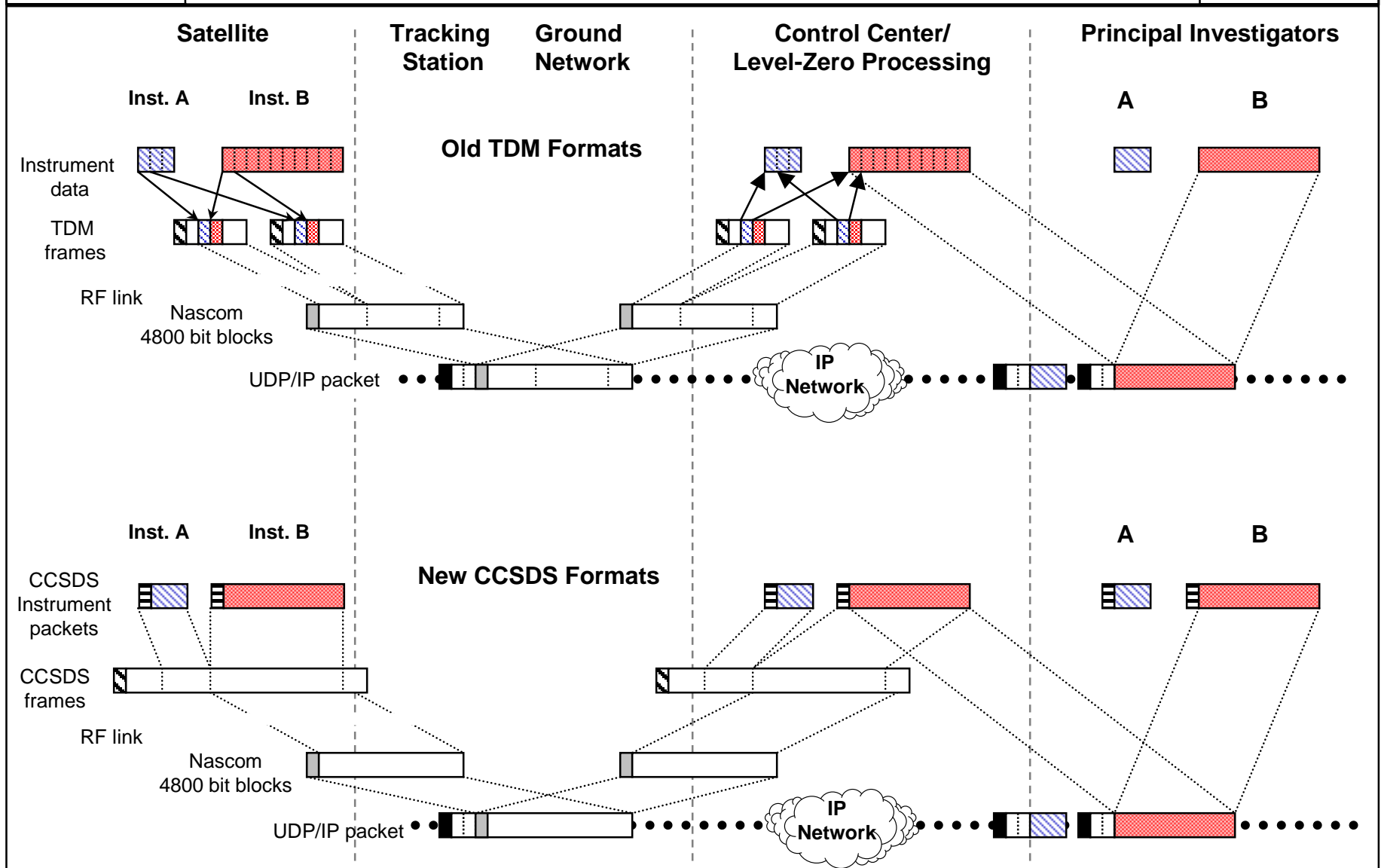



## Standard IP Communication Concept

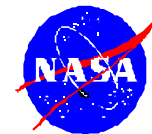

- The NASA/GSFC Codes 451, 581 and 588 are pursuing projects that demonstrate the feasibility of using COTS Internet hardware and software to support NASA science missions such as satellites, balloons, and remote field sites
- The OMNI prototype is being developed and demonstrated to remove myths and misconceptions about the Internet Protocol “not working” in space
- The basic approach is to make all remote science systems “nodes on a network”
- Using an IP network backbone provides the following benefits:
  - Scientists are familiar with the Internet and its collaboration capabilities
  - No special communication hardware is needed at ground systems or end users
  - A wide range of COTS hardware and software solutions exist and their development, debugging and ongoing maintenance is paid for by someone else
  - Collaborative science missions are possible since IP provides a common communication mechanism between science systems
- Data for most NASA missions is delivered over IP backbones today (TDM or CCSDS frames in Nascom 4800 bit blocks delivered over UDP/IP by Nascom and DSN)



# Standard IP Communication Concept

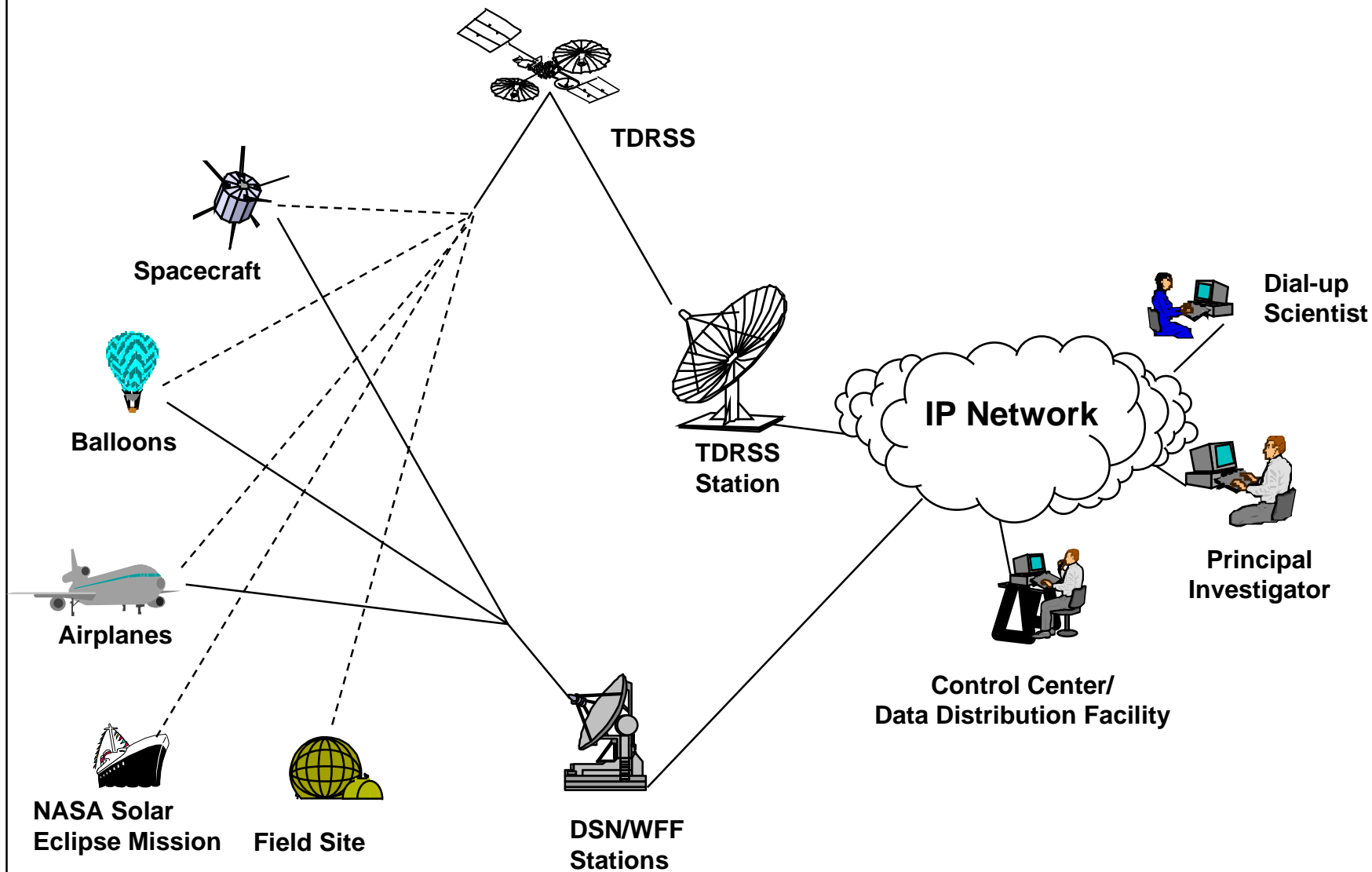
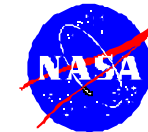



## IP Based Mission Data Flows

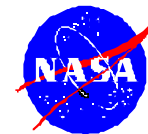

- Instrument records are generated, written to onboard files if desired and IP network addresses are added to identify a destination
- Connection-less UDP/IP delivery is used for “unreliable” data delivery (unaffected by propagation delay and errors, operates over a simplex communication path)
- Connection-oriented TCP/IP is used for “reliable” data delivery (sensitive to propagation delay and errors, requires a duplex communication path)
- IP packets flow through RF communication links to tracking stations and are routed across Internets using standard networking equipment
- IP packets can flow unmodified from an instrument to any end user (end user can be control centers, LZP, scientists, or other satellites, balloons, etc.)
- No custom processing facilities are required to reformat data for basic delivery
- Files of data from each instrument can flow directly to scientists without requiring intermediate processing
- The reduction in custom hardware, software and intermediate processing systems results in significant cost savings and quicker data delivery for a mission



# IP Based Mission Data Flows

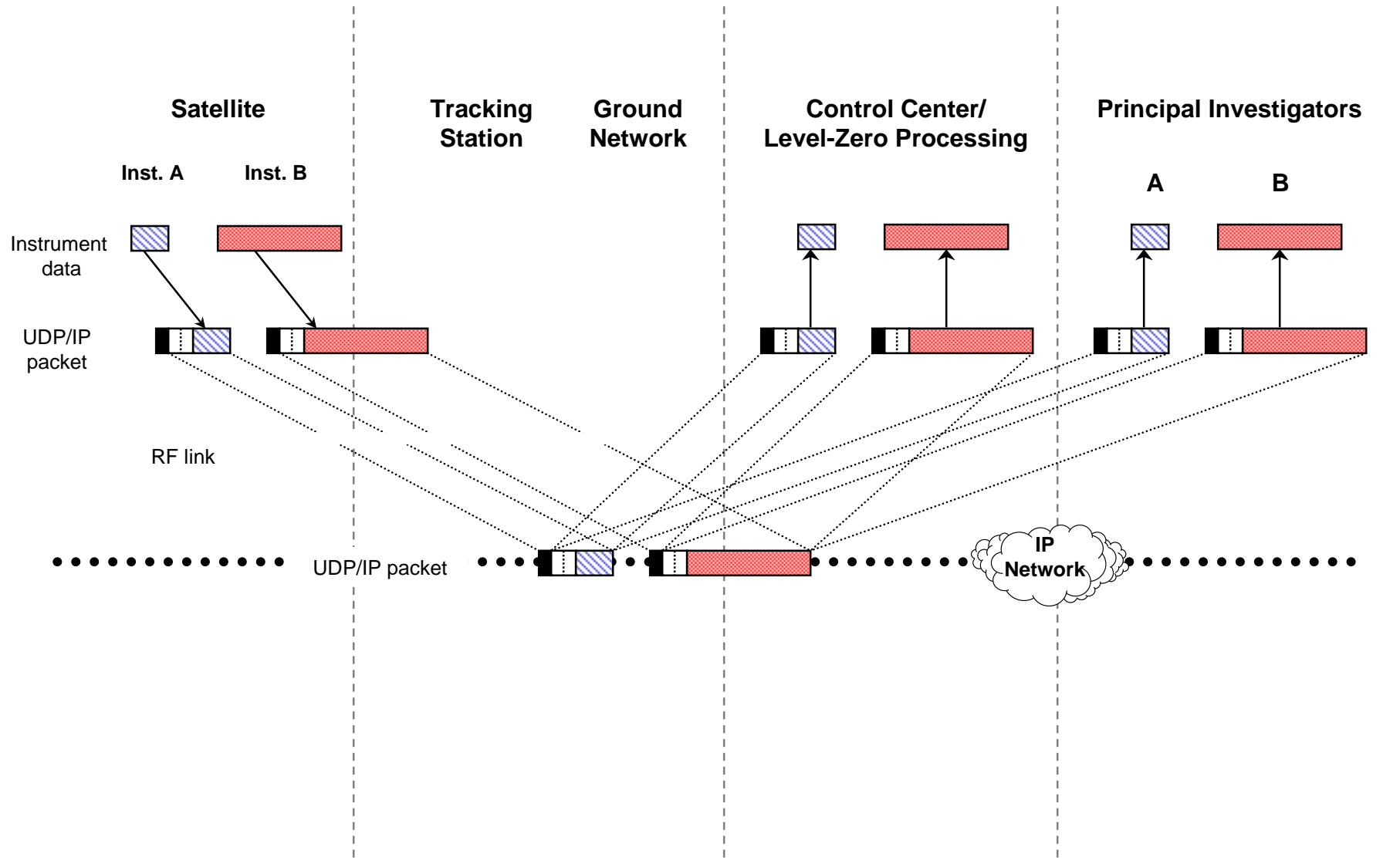



## End-to-End IP Communication Prototype



- The basic goal of the OMNI prototype is to demonstrate that IP works over space links and to investigate issues of LAN based satellites, balloons, etc.
- IP provides end-to-end data delivery and makes the science system a “node on a network”. Various upper layer protocols can be used for file transfers, status monitoring and commanding
- The OMNI prototype consists of a simulated satellite (VME chassis, PPC 603 processor, VxWorks real-time OS) with 3 “science instruments”
  - GPS receiver (RS-232 interface)
  - Weather station (RS-232 interface)
  - Video webserver (Ethernet interface, multiple cameras)
- The prototype demonstrates real-time and playback data similar to a real satellite
  - Real-time data - records sent in real-time using UDP/IP
  - Playback data - records logged to files for later transfer via FTP/TCP/IP
- Commanding can be done via UDP or TCP
- The laboratory demonstration uses a simulated RF link (Adtech channel simulator)
- Outdoor demos use a TDRSS RF link for demonstration of full mobile, intermittent access to the science equipment





# End-to-End IP Communication Prototype

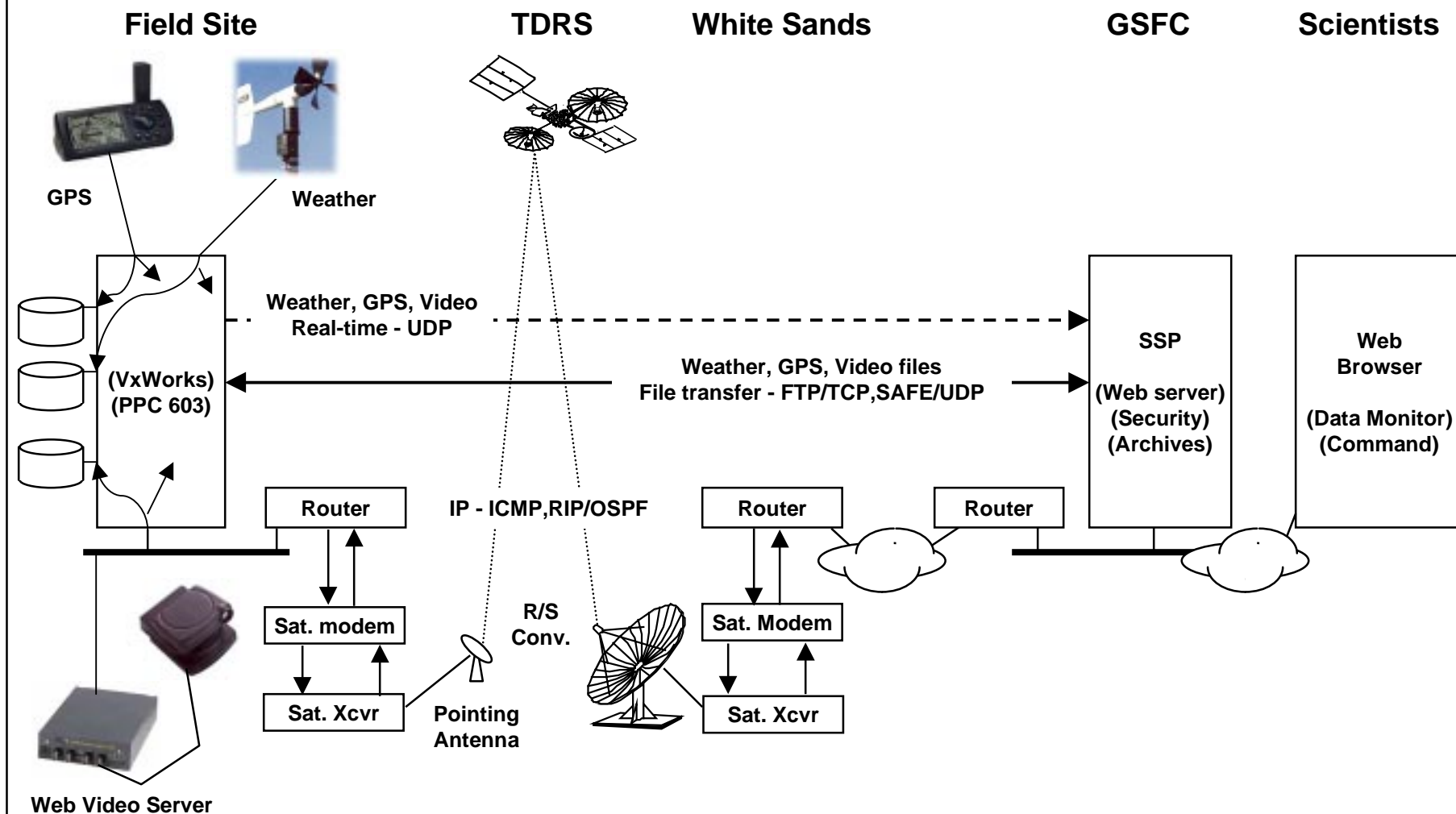
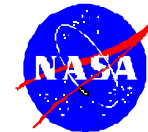



## End-to-End Satellite Networking Issues

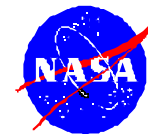

- The key component in the architecture is the IP network layer and its basic ability to deliver packets between any network source and destination
- Lower layer key issues (communication links support common IP packet delivery)
  - IP network exists between all ground systems
  - Satellite LAN and router technology is the first step in implementing IP onboard satellites
  - Standards are needed for the router serial interfaces over science system RF links
  - Standard transceiver interfaces are needed (TDRSS project is working on new transceivers)
- Upper layer key issues (IP provides a common interface to upper layer software)
  - Standard satellite operating systems are needed which support standard networking protocols (i.e. FTP/TCP/UDP/IP) and file systems for separating instrument and housekeeping data
  - Work is needed in structuring satellite subsystems with more distributed processing concepts so they can operate as “nodes on a network”
- The OMNI prototype has demonstrated live data flows over TDRSS using standard IP
- The OMNI prototype will be used August 11, 1999 on a cruise ship in the Black Sea to return live images and weather information on the last total solar eclipse of the millennium.
- Discussions are underway with commercial software and hardware manufacturers to develop the missing components for end-to-end IP support



# End-to-End Satellite Networking Issues

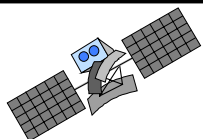
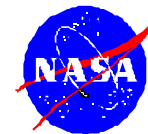

Spacecraft/Balloon  
Field Site



Tracking  
Station



Control Center  
Data Distribution



PI



Dial-up  
Scientist

Virtual Instruments  
Constellations of Satellites

Scientist Interface with Instrument  
Instrument Prepared Data Products  
Email, FTP, NFS Data Delivery to Scientist

Spacecraft Monitoring / Commanding (SNMP, CMIS/CMIP, MMS, FMS, etc.)  
Email, FTP, NFS to Control Center  
Instrument / Spacecraft Autonomy

Satellite Software Systems  
OBC, OS, File sys., Storage  
UDP, TCP, NFS, FTP, etc.  
Common Functions  
GPS, Automation

Ground System Automation

Planning & Scheduling  
Resource Allocation / Conflict Resolution  
Command Management  
Data Storage / Archival  
Data Processing  
Data Distribution ( CDROM, WWW )

Instrument  
Subsystems

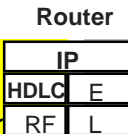
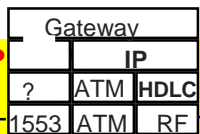
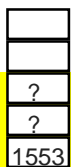
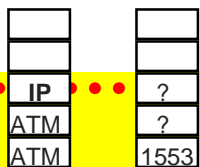

Tracking

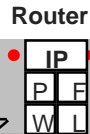

Control

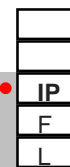

Data

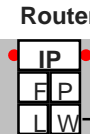
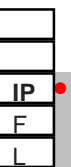

Scientist



Scientist



Onboard LAN / Bus  
Instrument Interface Standards  
Instrument Command Standards  
Instrument Data Storage  
Instrument Autonomy

Satellite Router/Gateway  
Data Link Protocols  
Gnd & Satellite Modem  
Remote Equip Mgmt  
Satellite Phone

Antenna / Receiver / Transmitter Management  
Mobile IP  
Contingency Modes  
Satellite Phone

E Ethernet L LAN P PPP  
F FDDI W WAN M Modem

Security



# Acronyms

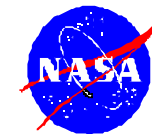

ATM	Asynchronous Transfer Mode	NASA	National Aeronautics and Space Administration
CCSDS	Consultative Committee for Space Data Systems	NFS	Network File System
CMIP	Common Management Information Protocol	OS	Operating System
CMIS	Common Management Information Services	OSPF	Open Shortest-Path First
COTS	Commercial Off-The-Shelf	PI	Principal Investigator
CSC	Computer Sciences Corporation	Power	Performance Optimization With Enhanced RISC
DSN	Deep Space Network	PPC	Power Personal Computer
FDDI	Fiber Distributed Data Interface	PPP	Point-to-Point Protocol
FTP	File Transfer Protocol	RF	Radio Frequency
GPS	Global Positioning System	RIP	Routing Information Protocol
GSFC	Goddard Space Flight Center	SAFE	Simple Automatic File Exchange
HDLC	High-level Data Link Control	SMTP	Simple Mail Transfer Protocol
ICMP	Internet Control Message Protocol	SNMP	Simple Network Management Protocol
IP	Internet Protocol	TCP	Transmission Control Protocol
IPSec	IP Security	TDM	Time Division Multiplex
LAN	Local Area Network	TDRSS	Tracking and Data Relay Satellite System
LZP	Level-Zero Processing	UDP	User Datagram Protocol
MMS	Manufacturing Messaging Specification	VME	Versabus Modula Europa
		VPN	Virtual Private Network
		WAN	Wide Area Network
		WFF	Wallops Flight Facility
		WWW	World Wide Web